

Dell Force10 S25 Systems

Quick Start Guide

Regulatory Model:
S25N/S25V/S25P



Force10

Dell Force10 S25 Systems

Quick Start Guide

Regulatory Model:
S25N/S25V/S25P



Force10

Notes, Cautions, and Warnings



NOTE: A NOTE indicates important information that helps you make better use of your computer.



CAUTION: A CAUTION indicates potential damage to hardware or loss of data if instructions are not followed.



WARNING: A WARNING indicates a potential for property damage, personal injury, or death.

If you purchased a Dell n Series computer, any references in this publication to Microsoft Windows operating systems are not applicable.

Information in this publication is subject to change without notice.

© 2011 Dell Inc. All rights reserved.

Reproduction of these materials in any manner whatsoever without the written permission of Dell Inc. is strictly forbidden.

Trademarks used in this text: Dell™, the DELL logo, Dell Precision™, OptiPlex™, Latitude™, PowerEdge™, PowerVault™, PowerConnect™, OpenManage™, EqualLogic™, KACE™, FlexAddress™ and Vostro™ are trademarks of Dell Inc. Intel®, Pentium®, Xeon®, Core™ and Celeron® are registered trademarks of Intel Corporation in the U.S. and other countries. AMD® is a registered trademark and AMD Opteron™, AMD Phenom™, and AMD Sempron™ are trademarks of Advanced Micro Devices, Inc. Microsoft®, Windows®, Windows Server®, MS-DOS® and Windows Vista® are either trademarks or registered trademarks of Microsoft Corporation in the United States and/or other countries. Red Hat Enterprise Linux® and Enterprise Linux® are registered trademarks of Red Hat, Inc. in the United States and/or other countries. Novell® is a registered trademark and SUSE™ is a trademark of Novell Inc. in the United States and other countries. Oracle® is a registered trademark of Oracle Corporation and/or its affiliates. Citrix®, Xen®, XenServer® and XenMotion® are either registered trademarks or trademarks of Citrix Systems, Inc. in the United States and/or other countries. VMware®, Virtual SMP®, vMotion®, vCenter®, and vSphere® are registered trademarks or trademarks of VMWare, Inc. in the United States or other countries.

Other trademarks and trade names may be used in this publication to refer to either the entities claiming the marks and names or their products. Dell Inc. disclaims any proprietary interest in trademarks and trade names other than its own.

Regulatory Model: S25N/S25V/S25P

2011 - 9 P/N 0594R1 Rev. A00

About this Guide

This document is intended as a Quick Start Guide to get new systems up and running and ready for configuration. For complete installation and configuration information, refer to the following documents:

Documentation	S25N/S25V	S25P
Hardware installation and power-up instructions	<i>Installing S25N and S25V Systems</i>	<i>Installing the S25P System</i>
Software configuration	<i>FTOS Configuration Guide</i>	<i>FTOS Configuration Guide</i>
Command line interface	<i>FTOS Command Line Reference Guide</i>	<i>FTOS Command Line Reference Guide</i>
Latest updates	<i>FTOS Release Notes for the S-Series</i>	<i>FTOS Release Notes for the S-Series</i>

Installing the Hardware

This guide assumes all site preparation has been performed before installing the chassis.

Installing the Chassis in a Rack or Cabinet

To install the S25N, S25V, or S25P system, Dell Force10 recommends that you complete the installation procedures in the order presented below.



NOTE: Unless stated otherwise, the installation instructions below apply to the S25N, S25V, and S25P systems.

Always handle the system and its components with care. Avoid dropping the switch or its field replaceable units.



CAUTION: Always wear an ESD-preventive wrist or heel ground strap when handling the chassis and its components. As with all electrical devices of this type, take all necessary safety precautions to prevent injury when installing this system. Electrostatic discharge (ESD) damage can occur if components are mishandled.

Installing a Chassis in a Two-Post Rack

The chassis is shipped with the universal front-mounting brackets (rack ears) attached. Ensure that there is adequate clearance surrounding the rack to permit access and airflow.

The S25 chassis can be installed using several methods. This document describes the most common installation method: two-post rack. For information regarding other installation methods, refer to the *Installing S25N and S25V Systems* guide and the *Installing the S25P System* guide.

This document does not include stacking or installing stacked units. Refer to the *Installing S25N and S25V Systems* guide and the *Installing the S25P System* guide for details on stacking installation and cabling.

Step	Task
1	Dell Force10 recommends that one person hold the chassis in place while a second person attaches the brackets to the posts.
2	Position the unit in the rack. Secure the unit with two of the supplied screws through each bracket and onto the rack post. S25N/V

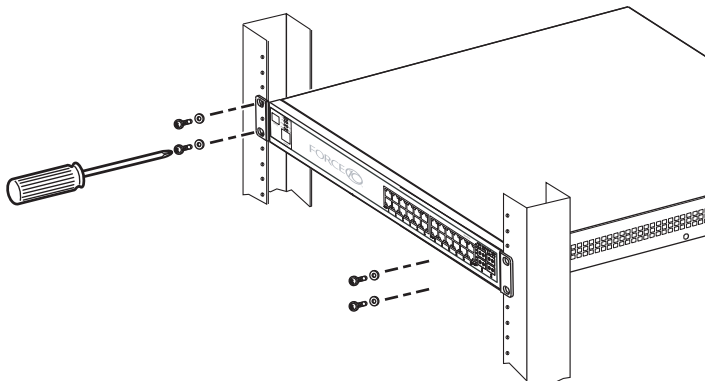

S25P

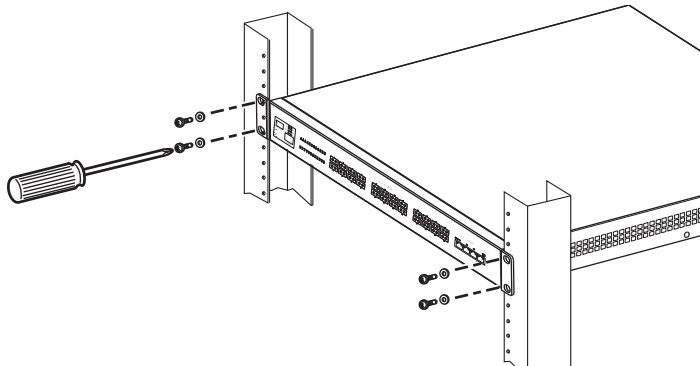

Attach a Ground Cable to the System

 **CAUTION:** To prevent electrical shock, make sure the switch is grounded properly. If you do not ground your equipment correctly, excessive emissions can result. Use a qualified electrician to ensure that the power cables meet your local electrical requirements.

 **NOTE:** The rack installation ears are not suitable for grounding.

 **CAUTION:** Grounding conductors *must* be made of copper. Do not use aluminum conductors.

 **NOTE:** Coat the one-hole lug with an anti-oxidant compound prior to crimping. Bring any un-plated mating surfaces to a shiny finish, and coat with an anti-oxidant prior to mating. Plated mating surfaces must be clean and free from contamination.

Connect the grounding cable to the FG terminal first (located on the PSU side of the chassis), then connect the opposite end to the appropriate grounding point at your site to ensure an adequate unit ground.

Install the SFP and XFP Optics

The S25 chassis have four receptacles on the I/O side that accommodate 10/100/1000 SFP optical transceivers. Additionally, the S25 has bays on the PSU side that accommodate optional CX4 or XFP modules.

A 10GbE module contains two ports. 10GbE modules should only be inserted or removed when the switch is powered down.

SFP and XFP transceivers can be inserted or removed while the switch is running.

 **CAUTION:** Before connecting a transceiver to a source, check the receive power of the transceiver with an optical power meter. Generally, Dell Force10 specified optics are not to be subjected to receive power higher than that stipulated by the optic specification. If the optic is exposed to optical power in excess of the specification, there is a high likelihood that it will be damaged.

Installing SFPs

 **NOTE:** When a copper SFP2 module with catalog number GP-SFP2-1T is used in the S25P switch, the SFP speed can be manually set with the **speed** command. When the speed is set to 10 or 100 Mbps, the **duplex** command can also be executed.

⚠ CAUTION: Electrostatic discharge (ESD) damage can occur if components are mishandled. Always wear an ESD-preventive wrist or heel ground strap when handling the chassis and its components.

⚠ WARNING: Follow all warning labels when working with optical fibers. Always wear eye protection when working with optical fibers. Never look directly into the end of a terminated or unterminated fiber or connector as it may cause eye damage.

Step	Task
1	Position the SFP so it is in the upright position. (The SFP optic has a key that prevents it from being inserted incorrectly.).
2	Insert the SFP into the port until it gently snaps into place. S25N/V with SFP

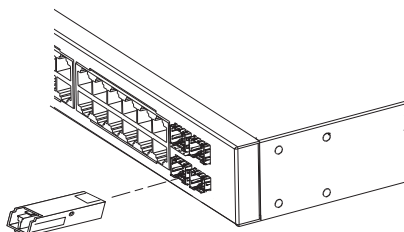

S25P with SFP

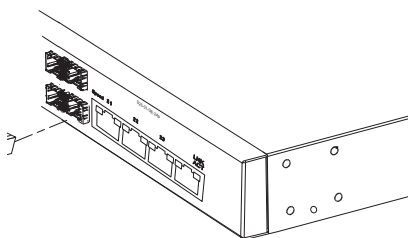

Installing XFPs

- △ **CAUTION:** Electrostatic discharge (ESD) damage can occur if components are mishandled. Always wear an ESD-preventive wrist or heel ground strap when handling the chassis and its components.
- ⚠ **WARNING:** Follow all warning labels when working with optical fibers. Always wear eye protection when working with optical fibers. Never look directly into the end of a terminated or unterminated fiber or connector as it may cause eye damage.
- △ **CAUTION:** You can insert and connect XFP transceivers while the switch is operating. You can also disconnect and remove XFP transceivers while the switch is operating. However, inserting or removing the module is not supported; it can crash or lock up the switch, requiring a reboot.
- △ **CAUTION:** The CX4 module does not use transceivers. However, you can use a CX4 cable with an XFP port by inserting a CX4 XFP converter (catalog name GP- XFP-1CX4) into the slot. An XFP port does not support the use of the cx4-cable-length command.

Step	Task
1	Position the XFP so it is in the upright position. (The XFP optic has a key that prevents it from being inserted incorrectly.)
2	Insert the optic into the port until it gently snaps into place.

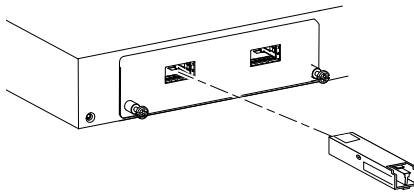



NOTE: For details on Dell Force10 supported optics, refer to <http://www.force10networks.com/products/specifications.asp>

Power Up Sequence

Supply Power and Power Up the System

There is no power switch. Supply power to the unit only after it is mounted.

 **CAUTION: To prevent electrical shock, make sure the switch is grounded properly. If you do not ground your equipment correctly, excessive emissions can result. Use a qualified electrician to ensure that the power cables meet your local electrical requirements.**

 **NOTE:** A US AC power cable is included in the shipping container for powering up an AC power supply. All other power cables must be ordered separately.

S25N

The S25N has two AC receptacles in the PSU side of the unit. The system can use either power source independently, or act in load-sharing mode.

S25V

The S25V has both an AC (3-prong plug receptacle) and a DC (-48V terminal-type) connection on the PSU side of the unit. Each power source can be used independently or in load-sharing combination. In other words, you have three options for providing power to the switch — AC only, DC only, or using both AC and DC sources.

- To use AC only, connect the supplied AC power cord first to the switch (receptacle on the right as you face the PSU side of the unit) and then to the power source. Connect the plug to the AC receptacle, making sure that the power cord is secure.
- For DC power, you must provide your own cables to connect to the power source. Cables must be sized for 11.5 A service at no more than -48 VDC input.

Step	Task
1	Make sure that the remote power source (the circuit breaker panel) is in the OFF position.
2	Remove the safety cover from the DC terminal block.

Step	Task
3	Connect the -48 V and -48 V RTN (Return) cables to the switch terminals and then to the remote power sources.
4	Replace the safety covers on the DC terminal block.

S25P

The S25P has two AC power supplies acting in load-sharing mode or can be used independently. Use the power cords shipped with the S25P to connect it to AC power outlets, ideally on separate circuits. Several versions of the power cord are available, based on country requirements.

S25P-DC

The PSU side of the S25P-DC contains two terminal blocks for two DC power supply inputs acting in load-sharing mode. The left terminal block, as you face the PSU side, corresponds to the DC2 status LED on the I/O side of the switch; DC1 is on the right. Cables must be sized for 11.5 A service at -48VDC input (per NEC in the United States. Internationally, follow local safety codes.)

Step	Task
1	Make sure that the remote power source (the circuit breaker panel) is in the OFF position.
2	Remove the safety cover from the DC terminal block.
3	Connect the grounding cable to the FG terminal first, then connect the opposite end to the appropriate grounding point at your site to ensure an adequate chassis ground.
4	Connect the -48 V and -48 V RTN (Return) cables to the switch terminals and then to the remote power sources, ideally on separate circuit breakers.
5	Replace the safety covers on the DC terminal blocks.
6	If you are connecting both terminal blocks, do not supply power until both terminal blocks are connected. You can supply power to either one or both. The S25P-DC uses the power supplies in load-sharing mode and does not set a precedence for either power source. Failover is hitless.

 **CAUTION: Electrostatic discharge (ESD) damage can occur if components are mishandled. Always wear an ESD-preventive wrist or heel ground strap when handling the system and its components.**

Power Supplies

On the S25N, S25V, and S25P systems, either the AC or DC power supplies alone are sufficient to power the switch. When both AC and DC power supplies are connected, they act in roughly a 60%/40% load-sharing mode.

 **WARNING: To prevent electrical shock, make sure the system is grounded properly. If you do not ground your equipment correctly, excessive emissions may result. Use a qualified electrician to ensure that the power cables meet your local electrical requirements.**

Fans

Ventilation is side-to-side, on the switch as you face the I/O side. The fans operate at a constant speed and with automatic speed adjustment for temperature changes.

Switch	Number of Fans
S25N	4
S25V	5
S25P	6

For the S25N and S25V, FTOS turns on major and minor alarms and logs temperature warnings at the following temperatures (in degrees Celsius), and logs another message when the temperature returns to normal. The Command Line Interface (CLI) also reports an alarm. The fan speed changes accordingly.

Temperature Warnings (in Degrees Celsius)	S25N	S25V
Major On	62	60
Major Off	58	56
Minor On	60	58
Minor Off	50	47

Specifications

Chassis Physical Design

Parameter	S25N/V Specifications	S25P Specifications
Height	1.73 inches (4.4 cm)	1.73 inches (4.4 cm)
Width	17.32 inches (44.0 cm) (19" rack-mountable)	17.32 inches (44.0 cm) (19" rack-mountable)
Depth	16.73 inches (42.5cm) (standard 1 rack unit)	16.73 inches (42.5cm) (standard 1 rack unit)
Chassis weight with factory-installed components	19.5 pounds (approx.) (8.85 kg)	14.41 pounds (approx.) (6.54 kg)
Rack clearance required	Front: 5-inches (12.7 cm) Rear: 5-inches (12.7 cm)	Front: 5-inches (12.7 cm) Rear: 5-inches (12.7 cm)

Environmental Parameters

Parameter	S25N/V Specifications	S25P Specifications
Temperature	32° to 122°F (0° to 50°C) (-40° to 158°F (-40° to 70°C) non-operating (storage temperature)	32° to 122°F (0° to 50°C) (-40° to 158°F (-40° to 70°C) non-operating (storage temperature)
Maximum Thermal Output	S25N: 349.05 BTU/Hour S25V: 349.05 BTU/Hour	S25P: 305 BTU/Hour S25P-DC: 262 BTU/Hour
Maximum altitude	No performance degradation to 10,000 feet (3,048 meters)	No performance degradation to 10,000 feet (3,048 meters)
Relative humidity	10 to 85% non-condensing (operating) 5 to 95% non-condensing (storage)	10 to 85% non-condensing (operating) 5 to 95% non-condensing (storage)
Shock	MIL-STD-810	MIL-STD-810
Vibration	Telcordia GR-63-CORE	Telcordia GR-63-CORE

Parameter	S25N/V Specifications	S25P Specifications
ISO 7779 A-weighted sound pressure level	S25N: 42.0 dBA at 73.4°F (23°C) S25V: 42.9 dBA at 73.4°F (23°C)	45.1 dBA at 73.4°F (23°C)

Power Requirements

Parameter	S25N/V Specifications	S25P Specifications
Nominal Input Voltage	90 – 254 VAC, 47/63 Hz	S25P: 90 – 254 VAC, 47/63 Hz S25P-DC: -48 VDC
Maximum Current Draw	S25N: 2 A @ 100/120 VAC; 1 A @ 200/240 VAC S25V (AC): 6.5 A @ 100/120 VAC; 3.25A @ 200/240 VAC S25V (DC): 11.5A @ -48 VDC	S25P: 2 A @ 100/120 VAC; 1 A @ 200/240 VAC S25P-DC: 3.6 A @ -48 VDC
Minimum AC Current Draw	.35 A @ 254 VAC .62 A @ 90 VAC	.25 A @ 254 VAC .56 A @ 90 VAC
Maximum power consumption	S25N, S25V: 102W S25N (AC): 156W S25N (DC): 136W	S25P: 90W S25P-DC: 77W
Maximum PoE power	320W for PoE using either AC or DC inputs 790W for PoE using load-sharing AC and DC inputs	

Installing Power Supplies

The S25N, S25V, and S25P are shipped with power supplies installed and are not hot-swappable.

Installing the Software

Navigating CLI Modes

The FTOS prompt changes to indicate the CLI mode. You must move linearly through the command modes, with the exception of the **end** command which takes you directly to EXEC Privilege mode; the **exit** command moves you up one command mode level.

Console Access

Access the command line through a serial console port or a Telnet session. When the system successfully boots, you enter the command line in the EXEC mode.



NOTE: You must have a password configured on a virtual terminal line before you can Telnet into the system. Therefore, you must use a console connection when connecting to the system for the first time.

Serial Console

The RS-232 console port is labeled on the chassis. It is in the upper right-hand side, as you face the PSU side of the chassis.

Step	Task
3	<p>Set your initial console terminal settings to match the default console settings on the switch.</p> <p>9600 baud rate</p> <p>No parity</p> <p>8 data bits</p> <p>1 stop bit</p> <p>No flow control (console port only)</p> <p>After establishing a connection, you can modify the settings to match at each end of the connection.</p>
4	<p>S25P only: If you use the console port to download software to the switch, you will probably want to raise the console baud rate. Establish a connection with the default settings to verify the connection. Then use the lineconfig command to access the Line Config mode, and use the serial baudrate command to raise the baud rate on the console port. (Match the settings in your terminal access program.)</p>

Accessing the Console Port

Connect the RJ-45/DB-9 adapter that is shipped with the S25P system to the RJ-45 cable.

Table 2-1. Pin Assignments for Console Port

Signal	RJ-45 Pinout
NC	1
NC	2
RXD	3
GND	4
GND	5
TXD	6
NC	7
NC	8

Default Configuration

A version of the Dell Force10 Operating System (FTOS) is pre-loaded onto the chassis, however the system is not configured when you power up for the first time (except for the default hostname, which is `Force10`). You must configure the system using the Command Line Interface (CLI).

Configure Layer 2 (Data Link) Mode

Use the **switchport** command in INTERFACE mode to enable Layer 2 data transmissions through an individual interface. The user cannot configure switching or Layer 2 protocols such as spanning tree protocol on an interface unless the interface has been set to Layer 2 mode.

Step	Task	Command Syntax	Command Mode
1	Enable the interface.	no shutdown	INTERFACE
2	Place the interface in Layer 2 (switching) mode.	switchport	INTERFACE

To view the interfaces in Layer 2 mode, use the **show interfaces switchport** command in the EXEC mode.

Configure a Host Name

The host name appears in the prompt. The default host name is `Force10`.

- Host names must start with a letter and end with a letter or digit.
- Characters within the string can be letters, digits, and hyphens.

Task	Command Syntax	Command Mode
Create a new host name.	hostname <i>name</i>	CONFIGURATION

Access the System Remotely

You can configure the system to be accessed remotely by Telnet.

The S25N, S25V, and S25P systems do not have a dedicated management port, nor a separate management routing table. Configure any port on one of the chassis to be the port through which you manage the system and configure an IP route to that gateway.

Step	Task	Command Syntax	Command Mode
1	Configure an IP address for the port through which you will manage the system.	ip address	INTERFACE
2	Configure an IP route with a default gateway.	ip route	CONFIGURATION
3	Configure a username and password.	username	CONFIGURATION

Configure the Management Port IP Address

Assign IP addresses to the management ports in order to access the system remotely.



NOTE: Assign different IP addresses to each RPM's management port.

Step	Task	Command Syntax	Command Mode
1	Enter INTERFACE mode for the Management port.	interface ManagementEthernet <i>slot/port</i>	CONFIGURATION
2	Assign an IP address to the interface.	ip address <i>ip-address/mask</i>	INTERFACE
3	Enable the interface.	no shutdown	INTERFACE

Configure a Management Route

Define a path from the system to the network from which you are accessing the system remotely. Management routes are separate from IP routes and are only used to manage the system through the management port.

Task	Command Syntax	Command Mode
Configure a management route to the network from which you are accessing the system.	management route <i>ip-address/mask gateway</i>	CONFIGURATION

Configure a Username and Password

In FTOS, you can assign a specific username to limit user access to the system.

Task	Command Syntax	Command Mode
Configure a username and password to access the system remotely.	username <i>name</i> [access-class <i>access-list-name</i>] [no password password [<i>encryption-type</i>] <i>password</i>] [privilege <i>level</i>]	CONFIGURATION

Configure the Enable Password

The EXEC Privilege mode is accessed by the **enable** command. Configure a password as a basic security measure. When using a console connection, EXEC Privilege mode is unrestricted by default; it cannot be reached by a VTY connection if no password is configured. There are two types of enable passwords:

- enable password stores the password in the running/startup configuration using a DES encryption method.
- enable secret is stored in the running/startup configuration in using a stronger, MD5 encryption method.

Dell Force10 recommends using the enable secret password.

Task	Command Syntax	Command Mode
Create a password to access EXEC Privilege mode.	enable [password secret] [<i>level level</i>] [<i>encryption-type</i>] <i>password</i>	CONFIGURATION

Create a VLAN

The Default VLAN is part of the system startup configuration, and is by default, VLAN 1. You may make another VLAN the Default VLAN. The Default VLAN cannot be deleted, disabled, or configured (you cannot assign it an IP address), and only untagged interfaces can belong to it.

When an interface is configured, a switchport automatically places it in the default VLAN as an untagged interface. All switchports must belong to at least one VLAN, so to remove a switchport from the Default VLAN, you must place it as tagged or untagged in some other VLAN, or remove the switchport configuration.

Task	Command Syntax	Command Mode
Create a VLAN	interface vlan <i>vlan-id</i>	CONFIGURATION
Display all VLANs.	show vlan <i>vlan-id</i>	EXEC Privilege

Assign Interfaces to a VLAN

A port may either be an untagged member of a single VLAN, or a tagged member of perhaps multiple VLANs.

- Untagged Ports — ports that do not append an 802.1Q VLAN tag to frames on egress, and do not accept tagged frames on ingress (tagged frames are dropped). Untagged ports must be connected to VLAN-unaware devices.
- Tagged Ports — ports that append an 802.1Q tag to frames on egress, and accept only tagged frames on ingress (untagged frames are dropped). Tagged ports must be connected to VLAN-aware devices.

When you configure an enabled port as a switchport, the port is placed in the default VLAN. To remove a switchport from the default VLAN, remove the switchport configuration. To move the port to another VLAN, add it to the desired VLAN as either a tagged or untagged member.

To view just the interfaces that are in Layer 2 mode, enter the **show interfaces switchport** command in the EXEC mode.

Step	Task	Command Syntax	Command Mode
1	Assign a switchport to a VLAN.	[tagged untagged] <i>interface</i>	INTERFACE VLAN
2	Display all switchports and the VLANs of which they are members.	show vlan	EXEC Privilege

Assign an IP address to a VLAN



NOTE: An IP address cannot be assigned to the Default VLAN, which, by default, is VLAN 1. To assign another VLAN ID to the Default VLAN, use the default **vlan-id** *vlan-id* command.

Task	Command Syntax	Command Mode
Configure an IP address and mask on the interface.	ip address <i>ip-address</i> <i>mask [secondary]</i>	INTERFACE

Connecting the Chassis to the Network

Once you have completed the hardware installation and software configuration, you can connect to your company network by following your company's cabling requirements.



Printed in the U.S.A.

www.dell.com | support.dell.com



0594R1A00